



Simultix 15

Simultaneous wavelength dispersive X-ray fluorescence

Elemental analysis by WDXRF spectroscopy



Rigaku

Leading With Innovation



Simultix 15

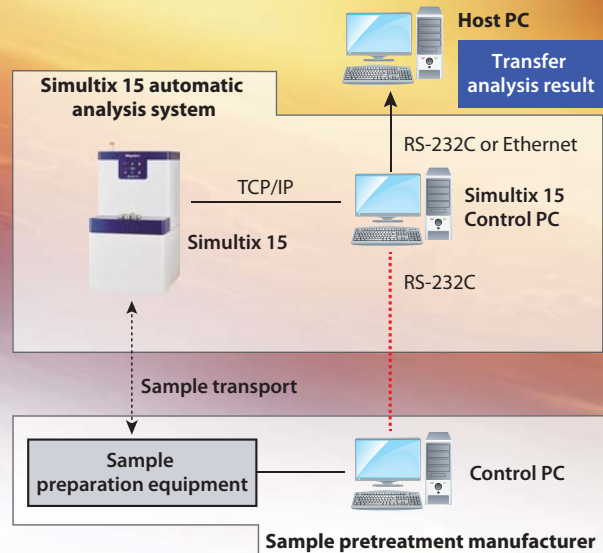

High-throughput elemental analysis for process control

For over 40 years, the Rigaku Simultix simultaneous wavelength dispersive X-ray fluorescence (WDXRF) spectrometer system has been widely used as an elemental analytical tool for process control in industries that require high throughput and precision, such as steel and cement. Nearly 1,000 Simultix systems have been delivered to customers around the world. Along with technological progress over these years, customer requirements have advanced and diversified as well. Simultix 15 was developed to meet these changing needs. It offers significantly improved performance, functions, and usability. The compact and intelligent Simultix 15 is a powerful analytical tool that demonstrates superior performance across many industrial sectors.



Fast, precise results

The most important metrics for automated process control are precision, accuracy and sample throughput. With up to 30 (and optionally 40) discrete and optimized elemental channels and 4 kW (or optionally 3 kW) of X-ray tube power, Simultix 15 delivers unparalleled analytical speed and sensitivity. Coupled to powerful but easy-to-use software, with extensive data reduction capabilities and maintenance functionality, this instrument is the perfect elemental analysis metrology tool.

Designed for automation

For high-throughput applications, automation is a fundamental requirement. Simultix 15 may be fitted with a 48-position Automatic Sample Changer (ASC). For full automation, the optional Sample Loading Unit provides right or left side belt-in feed from a third party sample preparation automation system.

Customized for your specific applications

What is XRF?

In X-ray fluorescence (XRF), an electron can be ejected from its atomic orbital by the absorption of X-rays (photons) from an X-ray tube. When an inner orbital electron is ejected (middle image), a higher energy electron transfers to fill the vacancy. During this transition, a *characteristic* photon may be emitted (right image) that is of a unique energy for each type of atom. The number of *characteristic* photons per unit time (counts per second or cps) is proportional to the amount of that element in a sample. Thus, qualitative and quantitative elemental analysis is achieved by determining the energy of X-ray peaks in a sample spectrum and measuring their associated count rates.

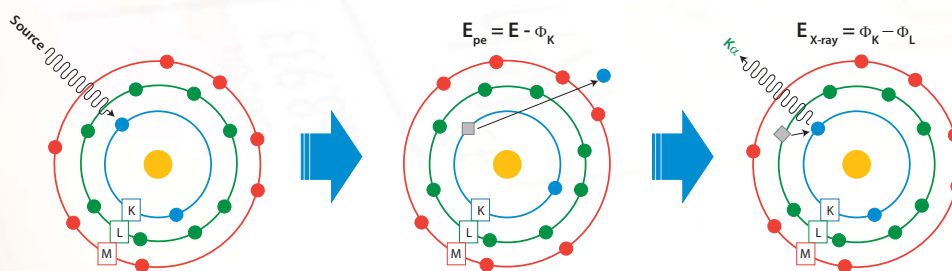

X-ray fluorescence schematic

How WDXRF works

Wavelength dispersive X-ray spectroscopy (WDXRF) is a method used to separate and measure the *characteristic* fluorescent X-rays emitted from a sample. The technique employs an analyzing crystal to spatially spread the X-ray light, much like a prism spreads visible light into its component colors. The wavelength of the impinging X-ray and the crystal's lattice spacings are related by Bragg's law and produce constructive interference when they satisfy the Bragg equation. The X-rays emitted by the sample irradiate an analyzing crystal through a slit with a certain angle. X-ray light diffracted by the analyzing crystal is spatially spread out, so that *characteristic* photons may be collected by a detector positioned at a precise angle to record the X-ray intensity of a specific element.

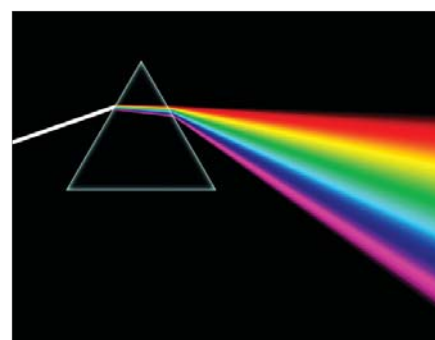

Analyzing crystals disperse radiation in the X-ray spectral region in the same way that a prism spreads the spectrum of visible light

Simultaneous WDXRF

In contrast to the more common *sequential* WDXRF instrumentation, where elements are measured one after the other using a scanning goniometer equipped with an analyzing crystal changer mechanism, *simultaneous* WDXRF speeds up the measurement process. Each Simultix 15 is customized for your specific applications with a set of discrete, optimized fixed channels for the elements of interest. All channels measure simultaneously – without moving parts, without time delay and without compromise. This makes *simultaneous* WDXRF the best solution in terms of time-to-result, precision, reliability, low cost-per-analysis and instrument longevity. For additional flexibility, Simultix 15 may be optionally equipped with a scanning goniometer for analysis of other elements as well as XRD channels for phase analysis.

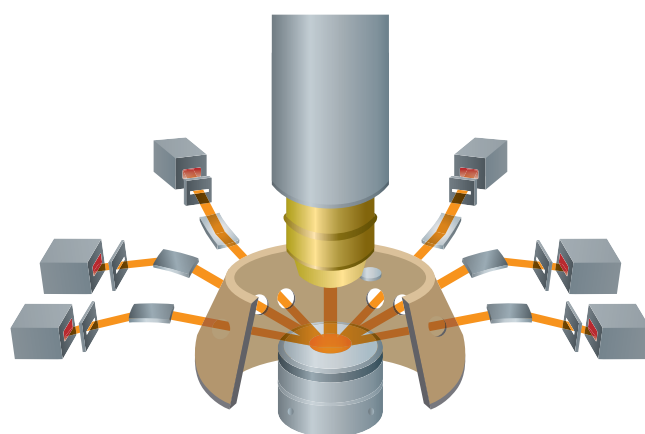

Schematic of Simultix 15 optics shows multiple fixed elemental channels that may be supplemented with a scanning goniometer for analysis of other elements or an XRD channel for phase analysis

Advanced technologies deliver superior performance

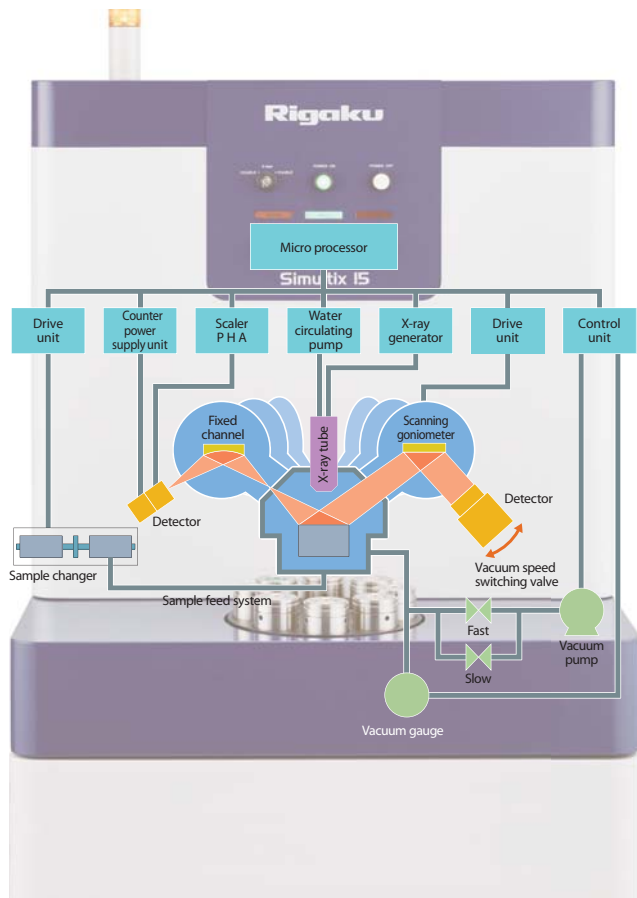

Designed for reliability

Simultix 15 incorporates many engineering advances to provide highest reliability and lowest cost of ownership. For example, a newly developed high-frequency, mold-type X-ray generator reduces both its size and energy consumption. The compact heat exchanger integrated into the main unit offers improved cooling efficiency to minimize water use and reduces the overall footprint of the system. To extend the life of the detectors, an X-ray shutter is activated between measurements. The enhanced reliability sample loading system lowers, moves laterally and raises the sample with a single motor, which results in smooth, high-speed sample loading.

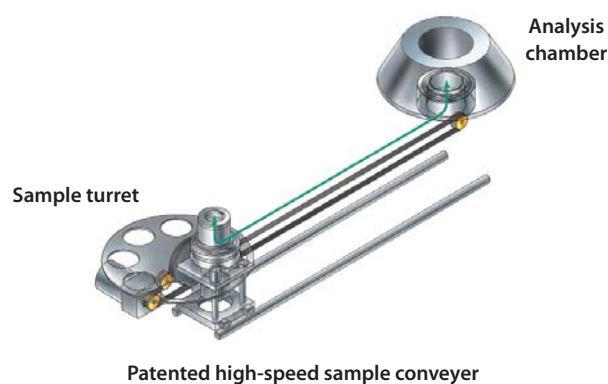

Heavy/light scanning goniometer

Optional wide elemental range goniometer supports standardless semi-quant (FP), and may be used for qualitative or quantitative determination of non-routine elements.

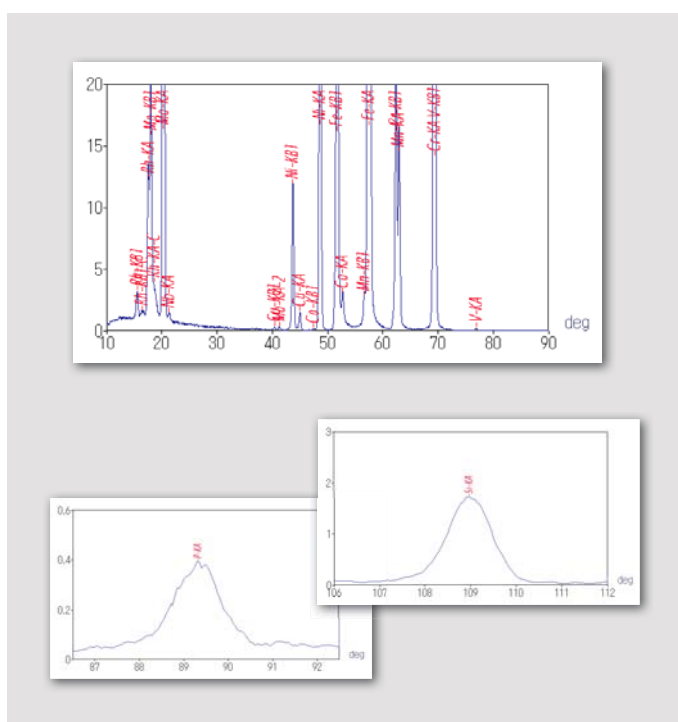

BG measurement for trace elements

Rigaku offers background measurement (BG) for fixed channels, resulting in improved calibration fits and superior accuracy. In the example below, background intensity of vanadium in stainless steel varies with metallic structure, such as ferrite, martensite and austenite. Net intensity corrected by background subtraction, using the background measurement function, affords a more accurate calibration.

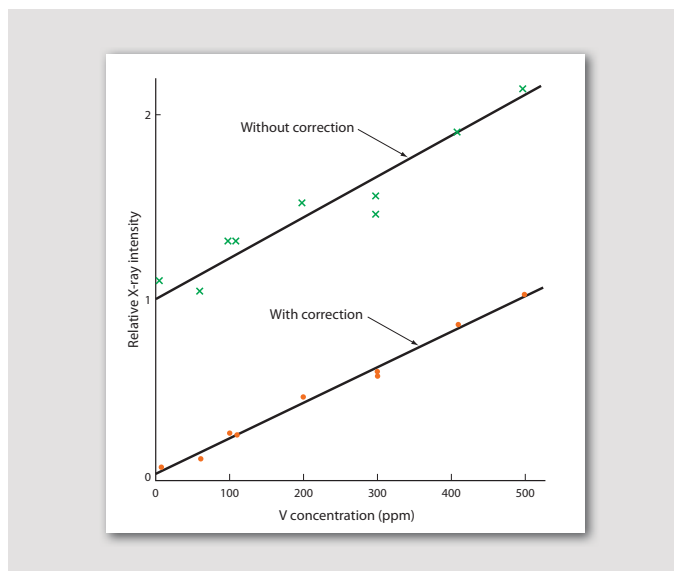

Ovonyx™ multilayer optics

Rigaku's Ovonyx product line has several advantages in the analysis of Be through Mg over competing multilayer or natural crystals. Reflectivity, high order suppression, reduced background, and stability to substances, temperature, and radiation damage make Ovonyx multilayers superior analyzers in light element spectroscopy. These newly developed synthetic multilayers enable analysis of elements down to Be, and improve precision for C and B. In the example shown at right, the RX85, featuring a unique logarithmically spiraled synthetic multilayer on a large curved substrate, delivers substantially higher sensitivity for beryllium (B) and boron (B) as compared to a conventional RX75 multilayer optic.



RX85 multilayer optic

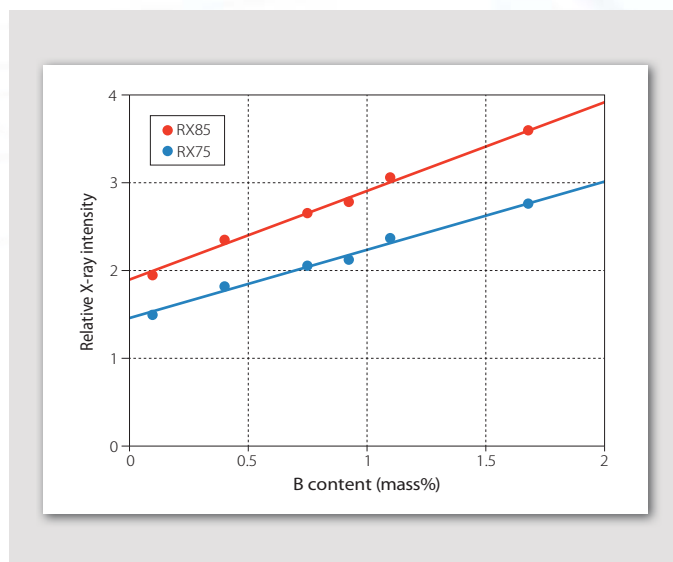

Automatic pressure control (APC) vacuum system

Both the evacuation and leak rates are switchable between two levels to minimize dispersal of powder or filter samples and to ensure stable long term operation. An optional powder trap prevents fine particles from entering the electrically controlled valves and vacuum pump. The APC system maintains a constant vacuum level in the optical chamber to dramatically improve light element analysis precision.

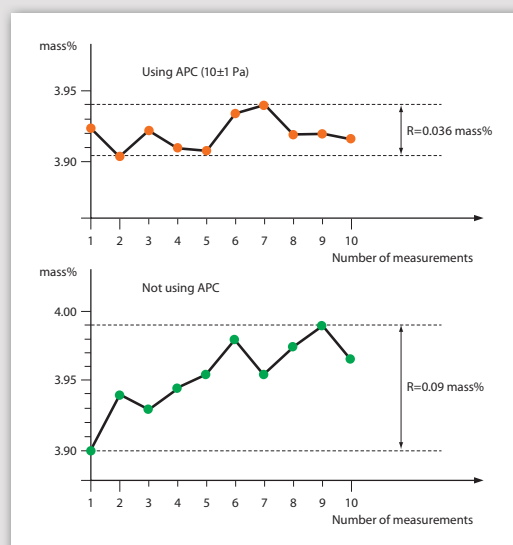
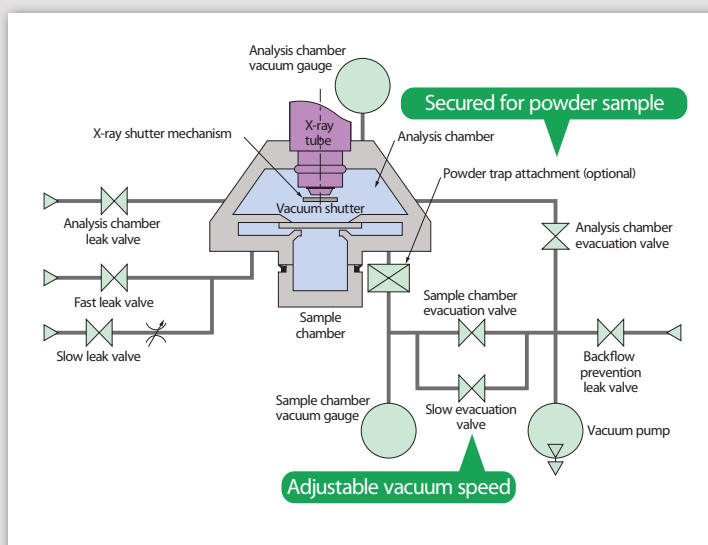

Simultaneous elemental analysis from $_4\text{Be}$ to $_{92}\text{U}$

Simultix 15

Be	B	C	N	O	F	Ne											
Na	Mg	Al	Si	P	S	Cl	Ar										
K	Ca	Sc	Ti	V	Cr	Mn	Fe	Co	Ni	Cu	Zn	Ga	Ge	As	Se	Br	Kr
Rb	Sr	Y	Zr	Nb	Mo	Tc	Ru	Rh	Pd	Ag	Cd	In	Sn	Sb	Te	I	Xe
Cs	Ba	Hf	Ta	W	Re	Os	Ir	Pt	Au	Hg	Tl	Pb	Bi	Po	At	Rn	
Fr	Ra	Rf	Db	Sg	Bh	Hs	Mt	Ds	Rg	Cn	Uut	Uuq	Uup	Uuh	Uus	Uuo	
La	Ce	Pr	Nd	Pm	Sm	Eu	Gd	Tb	Dy	Ho	Er	Tm	Yb	Lu			
Ac	Th	Pa	U														

- **Tube above optics**

Simultix 15 was engineered with inverted optics for superior reliability and instrument longevity. This configuration is especially important when analyzing powders, as it eliminates the risk of optical contamination.

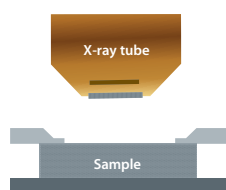

- **4 kW, 60 kV Rh-anode end-window X-ray tube**

Simultix 15 comes standard with a 4 kW X-ray tube. As an option, a 3 kW tube may be substituted.

- **Up to 40 fixed channels**

Simultix 15 has a standard 30 fixed channel configuration that may be optionally upgraded to 40 channels.

- **Up to 48-position automatic sample changer**

Standard 8-position autosampler may be optionally upgraded to a 48-position Automatic Sample Changer (ASC).

- **Belt loading automation**

Optional Sample Loading Unit provides right or left side belt-in feed from a third party sample preparation automation system.

- **Scanning goniometer**

Optionally available a choice of scanning goniometers. Heavy elements option covers $_{22}\text{Ti} - _{92}\text{U}$, while the heavy and light option can cover (depending on crystal selection) $_9\text{F} - _{92}\text{U}$.

- **Easy to clean**

Cleaning of the sample transport cup is easy. Conventional maintenance has been reduced.





- **Automatic pressure control (APC)**

APC system maintains a constant vacuum level in the optical chamber to dramatically improve light element analysis precision.

- **Improved easy-to-use software**

Simultix 15 software now has enhanced operability in quantitative analysis by adopting the analysis flowbar like the ZSX Primus series software.

- **Quantitative Scatter Ratio method**

When utilizing the Compton scattering ratio method, for ore and concentrate analysis, optional Quantitative Scatter Ratio method generates theoretical alphas for scattering ratio calibration.

- **Theoretical Overlap Correction**

Optionally available, the intensity for an overlapping line is calculated theoretically by the FP method and used for overlap correction.

- **BG measurement for trace elements**

Rigaku optionally offers background measurement (BG) for fixed channels, resulting in improved calibration fits and superior accuracy.

- **X-ray diffraction (XRD) channel**

Optional diffraction channel allows phase analysis, such as analysis of FeO in sinter or free lime in cement.

- **D-MCA system**

Digital multi-channel analyzer (D-MCA) delivers exceptional counting linearity at high counting rates.

- **Ovonyx™ multilayer optics**

Advanced RX-series optics are engineered and manufactured by Rigaku Innovative Technologies.

Available analyzing crystals

Crystal	Atomic number										
	10	20	30	40	50	60	70	80	90		
LiF(200)		¹⁹ K	—————								⁹² U
Ge	¹⁵ P, ¹⁷ Cl	■ ■									
NaCl	¹⁶ S	■									
RX6 ^{*1}	¹⁵ P	■									
RX4	¹⁴ Si	■									
PET	¹³ Al	■									
RX35 ^{*2}	⁸ O	■	¹² Mg								
TAP ^{*3}	⁹ F	■	¹² Mg								
RX45	⁷ N	■									
RX61	⁶ C	■									
RX85	⁴ Be	■	⁵ B								

*1 RX6: Copper alloy *2 RX35: High sensitivity *3 TAP: High resolution

Easy-to-use graphical interface

Improved software

With an eye toward the future, Rigaku has combined extensive experience in applications development and unsurpassed technical knowledge to create the world's best XRF analytical software. Simultix 15 software now has enhanced operability in quantitative analysis by adopting the analysis flowbar like the ZSX Primus series software. With a firm belief that knowledge is power, Rigaku has developed software that is not only user-friendly, but sophisticated and powerful enough for the most complex analysis. Simultix 15 Windows® based software was conceived and built with end-user needs and requirements in mind.

Results and status display

Another famous Rigaku innovation is the graphical instrument status window (shown at right). Real time display of key parameters allow users to access the condition of the spectrometer at a glance. This feature both saves the operator time and increases situational awareness.

Quantitative Scatter Ratio

When utilizing the Compton scattering ratio method, for ore and concentrate analysis, optional Quantitative Scatter Ratio method generates theoretical alphas for scattering ratio calibration by fundamental parameters.

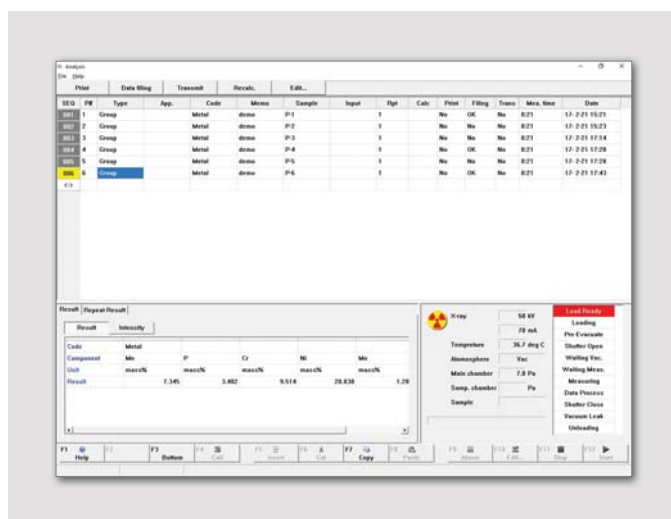
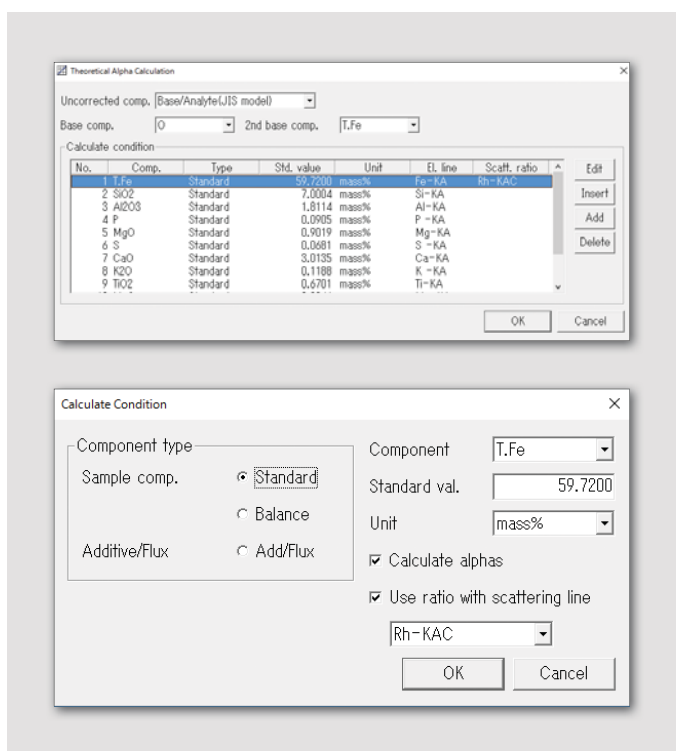

Quantitative functionality

Simultix 15 software offers a plethora of functionality for calibration and quantification in a simple user interface. In addition to absorption correction and line overlap correction, a variety of regression calculations for optimal fitting is available, including fixed point calibration and split calibration.

When using the theoretical alphas calculation with fundamental parameters (FP), it is possible to set up calibration curves with three models: Lachance-Trail, de Jongh, or JIS. For the fusion bead method, various calibration enhancements are available, including loss-on-ignition (LOI), dilution ratio, and the special Rigaku flux-evaporation correction.

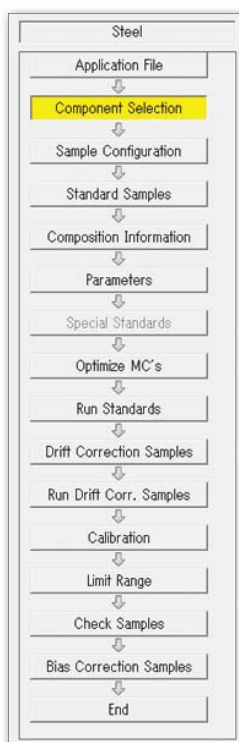

Flowbar guidance

Based on the famous Rigaku easy-to-use flowbar interface, Simultix 15 series software walks the user through the steps required to set up either an empirical or a fundamental parameters application. For empirical calibrations, the flowbar covers every detail, from setup of an application file to the selection of a template and the components to be measured. The user is then guided through acquisition parameters setup, the setup of standards and drift correction, through calibration and reporting.

Theoretical overlap correction

Optionally available is a correction employing theoretical X-ray intensities (screens at right). Intensity for an overlapping line is calculated theoretically by the FP method and used for overlap correction. This method provides a substantially more accurate result than the conventional approach of overlap correction with measured intensity. Therefore, no additional channels are required for overlap correction, since it is no longer necessary to measure overlapping lines.

Automatic group selection

Automatically selects an analysis protocol for each sample, based on a 1 second pre-analysis measurement. The simple setup windows are shown below. Eliminating the need to select an analysis program means that operators do not have to know applications or calibrations used for routine analyses.

Qualitative analysis

When optioned with the newly designed scanning goniometer for both heavy and light elements, Simultix 15 can provide qualitative (automatic peak identification, see below) and semi-quantitative analysis with similar performance to that of sequential WDXRF systems.

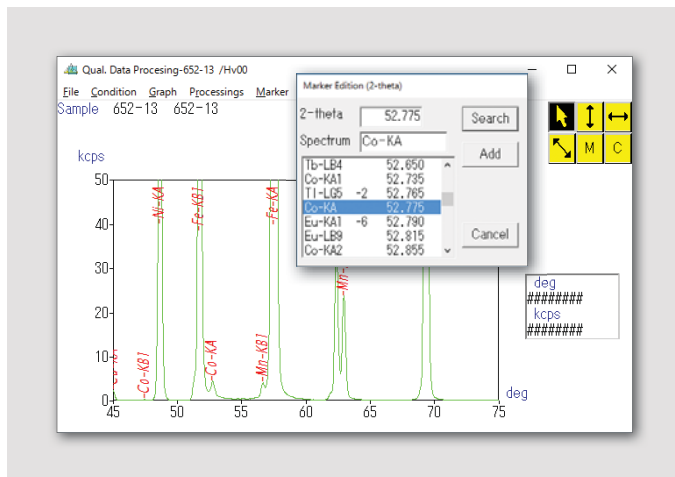
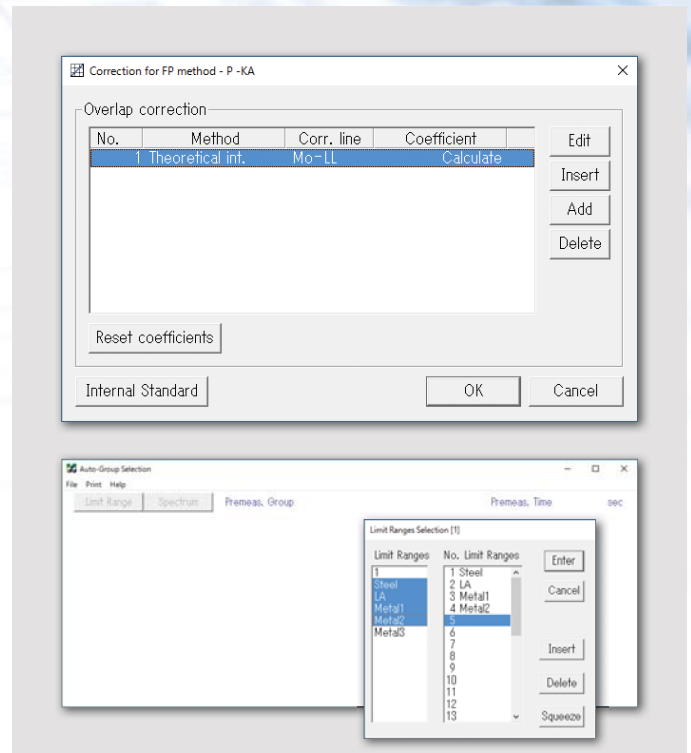

Applications span global industries



Mining and minerals

Simultix 15 employs a tube-above design that is ideal for situations where operating conditions may not be optimal.



Metals and alloys

Rigaku offers specialty and curved analyzing crystals, delivering the highest possible resolution and intensity for measurement of transition metals.

Fe in galvanneal zinc (GA) plating

Combination of optical optics and thin film FP method enables accurate analysis of Fe content in GA plating. Patent pending.

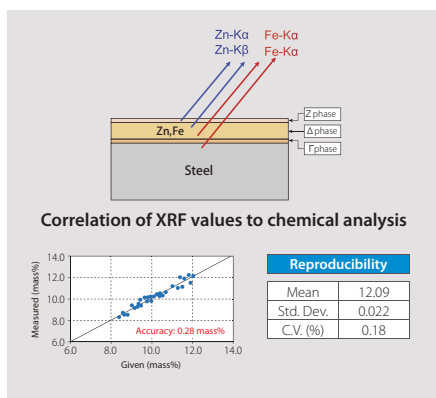

High precision analysis of barium titanate

High-precision molar ratio analysis is required for barium titanate, which is a high dielectric material. High repeatability analysis with $\sigma = 0.0001$ is possible.

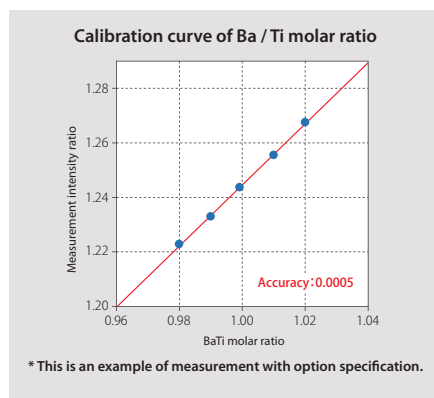

Quantitative analysis of free lime in cement clinker

Quantitative analysis of f-CaO in cement clinker is possible by mounting CaO diffraction channel.

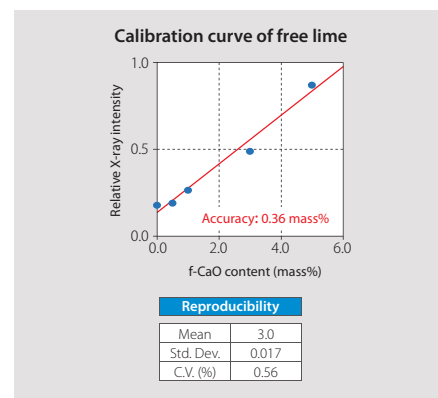

Quantitative analysis of iron ore

For analysis of pressed powder samples of ores and concentrates, more accurate analysis is possible by using the theoretical matrix correction constant from Compton scattering as calculated by the FP method. It is also effective for copper ore, nickel ore and others. Patent pending

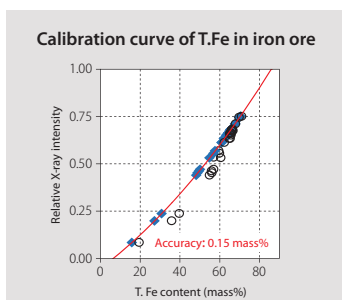

Quantitative analysis of FeO in sintered ore

By installing FeO diffraction channel, FeO in iron ore / sintered ore, quantitative analysis is possible.

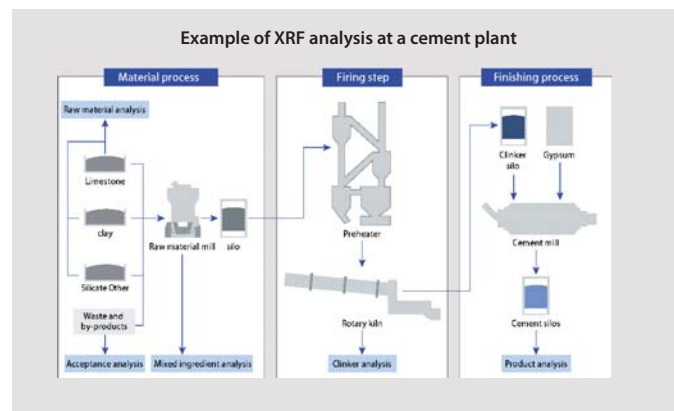
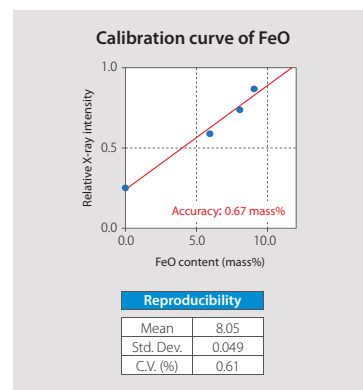

Specifications



Cement

When optioned with the XRD channel, free lime by direct phase measurement may also be obtained.



Chemicals

High throughput to meet quality control targets and international regulations, avoiding potential danger due to hazardous and toxic substances.

Installation requirements

Power supply	3-phase, 200 V \pm 10%, 50/60 Hz, 40 A Single-phase, 100 V \pm 10%, 50/60 Hz, 15 A, power outlet with ground connection (for PC)
Ground	Class D ground (independent), 30 ohms or less
Cooling water	Water pressure: 0.294 to 0.49 MPa Water temperature: 30°C maximum Water flow rate: 5 L/min Water quality: Tap water
Room temperature	15 to 28°C (Daily variation less than \pm 2°C within range)
Humidity	75%RH or less
Heat generated by equipment	1900 kcal/H
Installation area	3 m x 4 m minimum
Vibration	2 m/s ² or less (Lower than human sensitivity level)

Technical details

General	
Technique	X-ray fluorescence (XRF) spectroscopy
Type	Wavelength dispersive (WD), simultaneous
Optics	Tube above
Elemental coverage	⁴ Be through ⁹² U
X-ray generator	
X-ray tube	End window, Rh-anode, 4 kW, 60 kV (standard) End window, Rh-anode, 3 kW, 60 kV (optional)
HV power supply	High frequency inverter, ultra-high stability
Cooling	Internal water-to-water heat exchanger
Spectrometer	
Fixed channels	Up to 30 (standard), up to 40 (optional)
Scanning goniometer	Optional only with 30 channel configuration
Optics stabilization	Controlled temperature: 36.5°C
Sample changer	8 positions standard, 48 positions optional
Optical chamber	APC automatic pressure controller
Maximum sample diameter	51.5 mm
Sample rotation speed	60 rpm
Vacuum system	Direct coupled oil rotary pump (with mist catcher)
Atmosphere	Vacuum or air
Detectors	Scintillation counter (SC) Sealed proportional counter (S-PC) Flow proportional counter (F-PC)
Available options	XRD channel
Computer	
Type	PC
Operating system	Microsoft Windows
Printer	Dot-Matrix type or Ink-Jet type

Backed by Rigaku

Since its inception in 1951, Rigaku has been at the forefront of analytical and industrial instrumentation technology. Today, with hundreds of major innovations to our credit, the Rigaku Group of Companies are world leaders in the field of analytical X-ray instrumentation. Rigaku employs over 1,400 people worldwide in operations based in Japan, the U.S., Europe, South America and China.

Simultix 15

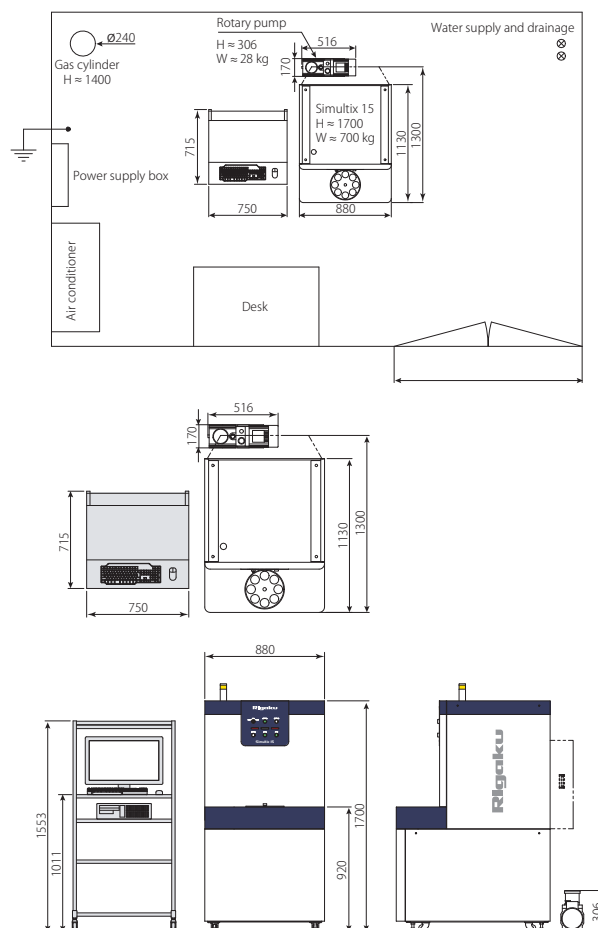

Rigaku

Leading With Innovation

Simultix 15

Simultaneous wavelength dispersive X-ray fluorescence

www.Rigaku.com/products/xrf/simultix



Rigaku Corporation and its Global Subsidiaries
website: www.Rigaku.com | email: info@Rigaku.com



Rigaku is proudly represented in
Australia and New Zealand by
AXT Pty. Ltd.
1/3 Vuko Pl., Warriewood
NSW 2102 Australia
T. +61 (0)2 9450 1359 F. +61 (0)2 9450 1365
W. www.axt.com.au E. info@axt.com.au